

5D4K0A

4000Wrms DVB-T/H UHF BIV-V SOLID STATE TRANSMITTER (forced air cooling system)

ELECTROLINK DVB-T/H UHF BIV-V TRANSMITTER LINE

5D4K0A Transmitter belongs to Electrolink high power DVB-T/H UHF BIV-V product family. Electrolink solid state digital transmitter generation covers a power range from 0,5W to 10kW (higher output power available on request). Each transmitter includes the following components:

- DVB-T/H Exciter
- Fully broadband power amplifiers
- Stainless steel transmitter rack with cooling system
- Power combiner
- Power distribution
- Control Logic unit (for local/remote control)
- Step-down transformers (with electrostatic shield)
- Band-pass filter (for critical and non-critical mask)

All transmitters can boast outstanding technical parameters, optimum cost/benefit ratio, maximum reliability and ease of servicing. All the transmitters can be equipped with dual exciter with automatic change-over unit (on request).

The transmitter control logic unit, equipped with a touchscreen display, can handle all the parameters and diagnostic about the equipment status and its related sub-units, providing all control functions. All transmitter and amplifier parameters required for diagnostics can be retrieved locally or remotely via standard (IP) protocol and standard software (web browser and lab-view application). Each power amplifier is self-protected and self-controlled.

Six step-down isolation transformers, used to provide a total redundancy and protection, are mounted on slide-out wheels in order to get ease installation and maintenance operations.



KEY FEATURES

- ❑ DVB-T/H exciter with touch screen graphical display
- ❑ "State of the Art" solid state technology
- ❑ Hotpluggable power amplifiers (with extender included)
- ❑ LDMOS transistors
- ❑ 19" standard rack clearly arranged and easily accessible
- ❑ Very high redundancy thanks to modular configuration
- ❑ Low junction temperatures of the RF transistors
- ❑ Six Step-down isolation transformers
- ❑ Each final stage disposes of its own power supply
- ❑ Remote/local control
- ❑ Protective circuits for the RF power transistors
- ❑ High suppression of intermodulation products
- ❑ Efficient low noise forced air cooling



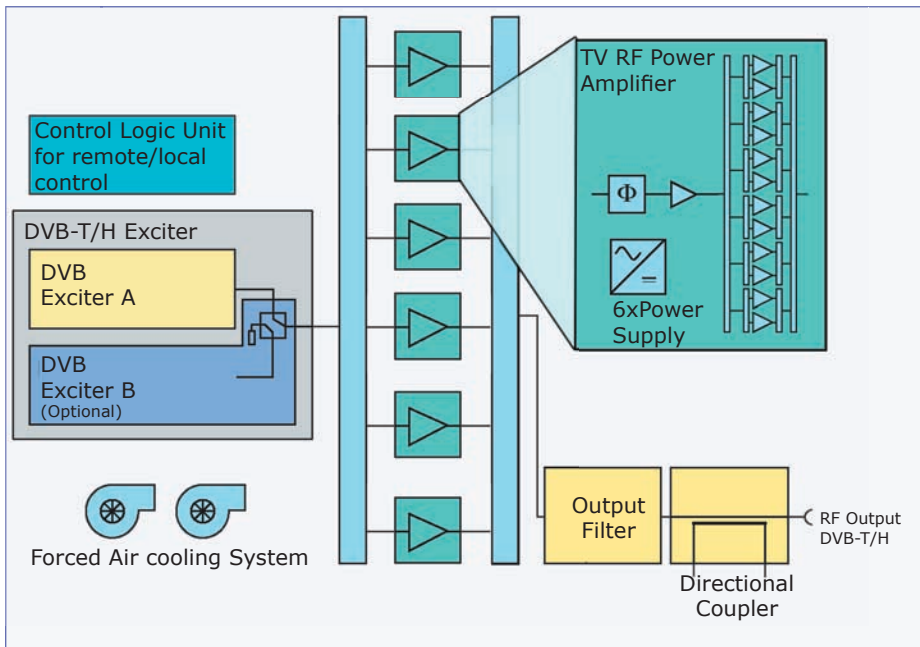

5D4K0A
Functional Block Diagram

DVB EXCITER (hierarchical mode) Rugged, compact, high performance, reliable and easy maintenance. Electrolink equips its transmitters with a DVB exciter that can support all the DVB-T and DVB-H modes, including hierarchical and non-hierarchical ones. Linear and non-linear precorrection are also available. Upon request, internal GPS can be provided. It can be used for SFN or MFN network and allows easy operation in any working conditions.

Completely microprocessor-controlled, it complies with all international standards. In the rear panel, 2 or 4 ASI data inputs are available, in order to have redundancy at the signals input and seamless switching during switchover. As alternative, the inputs can be used for DVB-T and DVB-H for hierarchical modulation. SFN adapter is used for data synchronization timing and an optional GPS receiver (integrated in the exciter) provides the required references. The exciter is fully compliant with ETS 300 744 specification, ensuring all the functions to convert any MPEG transport stream into COFDM modulated signal.

POWER AMPLIFIER Fully solid state and fully broad-band all over UHF BIV-V (from 470 up to 860MHz). All the power amplifiers are manufactured with LDMOS technology and are fully compliant with the ETS 300 744 specifications. The output power is displayed in the front panel by means of a multifunction display, where it is housed also the power amplifier control logic that manages all the information related to the power amplifier. For complete redundancy, each final stage (6 final stages per each power amplifier) has its own power supply and 3 blowers ensure the complete cooling of the power amplifier and total redundancy. The maximum output power is 700Wrms and it does not require any tuning. The power amplifiers are self-protected against VSWR, RF Input overdrive, over current, over voltage, over temperature and under voltage as well. Any power amplifier can be safely removed from the rack without interrupting operation, thanks to the isolated combination. The power amplifiers can be taken out without turning off the transmitter, thanks to the already included extender: this allows personnel to work into the power amplifiers with complete output power of the transmitter and in safe conditions.



CONTROL LOGIC UNIT Locally the transmitter can be controlled and operated via touch-screen graphical display and the front panel keypad (optional). The operators can always know the status of the transmitter and have a complete control of the equipment. The system is very user-friendly and help monitoring all the parameters of the complete system. On the right side, a needle meter always shows the output power. In addition, the transmitter can also be remote-monitored and remote-controlled via standard (IP) protocol and standard software (web browser and lab-view application).



MAINS DISTRIBUTION In order to ensure the complete power supply voltages, the transmitter is equipped with 6 step-down isolation transformers with electrostatic shield that can guarantee 100% redundancy. In case of fault phase lack or one/two transformers fault, the transmitter keeps on working automatically reducing the output power, but not turn off at all. This allows continuous on-air condition. Moreover, thanks to the use of the transformers, the power supplies are completely protected.



TECHNICAL SPECIFICATIONS

General Information

Frequency range	470 MHz to 862 MHz
Power supply	Single-phase 230 ±15% or 3-phase 230-380-415Vac ±15%
Frequency	47 to 63 Hz
Max. installation altitude	2.000 m above sea level (>2000 m on request)
Operating temperature range	+0°C to +45°C
Storage Temperature	-20°C to +70°C
Permissible relative humidity	95 %, non-condensing
Dimensions (W × D × H)	750 mm x 1230 mm x 1662 mm (x2)
RF Output Connector	3" 1/8 EIA

RF Characteristics

Output power	4.000Wrms
Power Consumption	≤ 25,5kVA
RF power stage technology	solid state LDMOS
TV Digital System Standards	DVB-T COFDM, 2K, 8K (4K for DVB-H on request) Compliant with EN 300 744, EN 302 304 (DVB-H)
Bandwidth	6MHz, 7MHz, 8MHz
External reference	10 MHz or TTL

Digital DVB-T/H Performance

Signal input	4xASI: BNC 75Ω, 2 Main / 2 hierarchical (option)
Modulation	QPSK, 16QAM, 64QAM
Guard Interval	1/4, 1/8, 1/16, 1/32
Inner Code Rate	1/2, 2/3, 3/4, 5/6, 7/8
Harmonic and spurious emissions	according to EN 320 296 (after filter)
Out-of-band emissions (Shoulder)	<-36dB (typ. -38dB) at ±4.2MHz (before filter, channel 8MHz) according to EN 302 296 (after filter)
MER	>34dB

Local and Remote Control

Local control	Touch-screen graphical display and front-panel keypad operation via user interface
Remote control	Parallel (D Connector) Web server and/or SNMP agent (optional)



Via delle Acacie - 05018 ORVIETO (TR) ITALY

General Information

electrolink@electrolink.com

Phone +39 0763 30 55 30

Fax +39 0763 39 03 66

Sales & Marketing

sales@electrolink.com

Phone +39 328 92 57 478

Phone +39 328 73 64 750

Fax +39 0763 39 03 66

Ventas y Comercialización

ventas@electrolink.com

Tel. +39 328 92 57 478

Fax +39 0763 39 03 66



UNI EN ISO 9001:2000 certified company
Registration Number: IT - 8848

